

ATENÇÃO: AS ESPECIFICAÇÕES DOS MATERIAIS SERÃO ENCONTRADAS NO MANUAL DESCRITIVO DE OBRAS.

Tribunal Regional Eleitoral de Santa Catarina		CARTÓRIO DA 32ª ZONA ELEITORAL - TIUBO	
		TRAVESSA V. FERREIRA FILIPE, Nº 1772 - ESCADA COM RUA DOUTOR DE OLIVEIRA - TIUBO/SC PROJETO DE SERRALHERIA DETALHAMENTO ESCADA DE ACESSO, CORRIMÃO, CORIMÃO E CORRIMÃO	
RESPONSÁVEL TÉCNICO:	Kathia Lopez Pereira Arquiteta responsável pelo projeto Arquiteta Responsável pelo Projeto	ESCALA:	INDICADA
PROJETO:	Rodrigo Palisani	PROJETO:	Projeto de Engenharia Civil 11/2023
PROJETO:	Pedro Schmidt Pomato Técnico de Arquitetura	PROJETO:	Projeto de Engenharia Civil 11/2023
PROJETO:	Ygor de Aguiar Ferraz dos Santos Técnico de Arquitetura	PROJETO:	Projeto de Engenharia Civil 11/2023
PROJETO:	ARQ 01/02	PROJETO:	Projeto de Engenharia Civil 11/2023

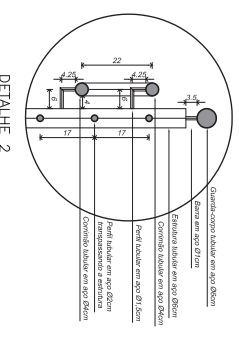
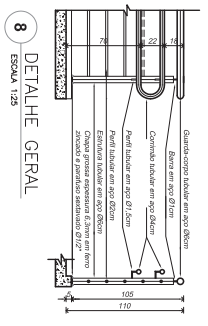
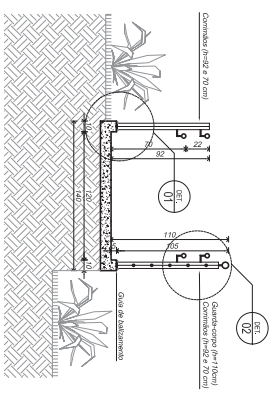
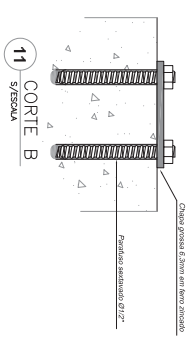
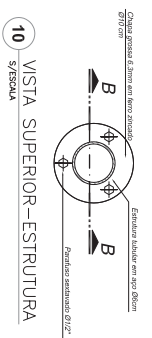
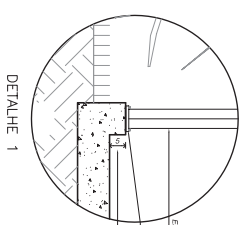
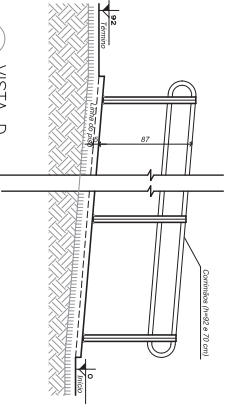
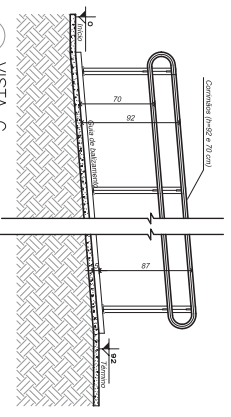
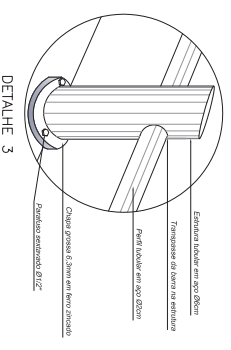
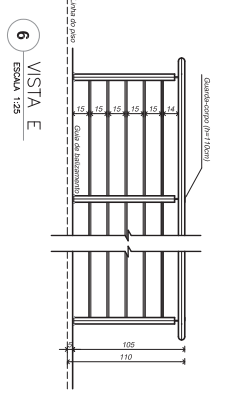
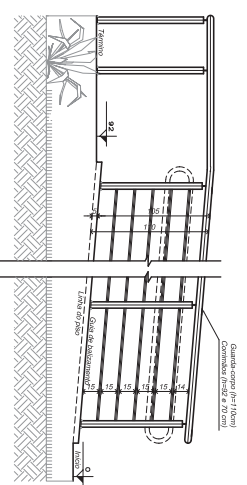
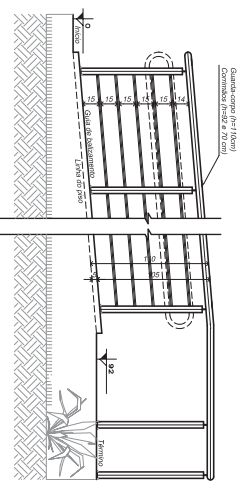
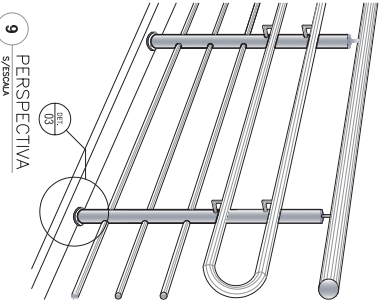
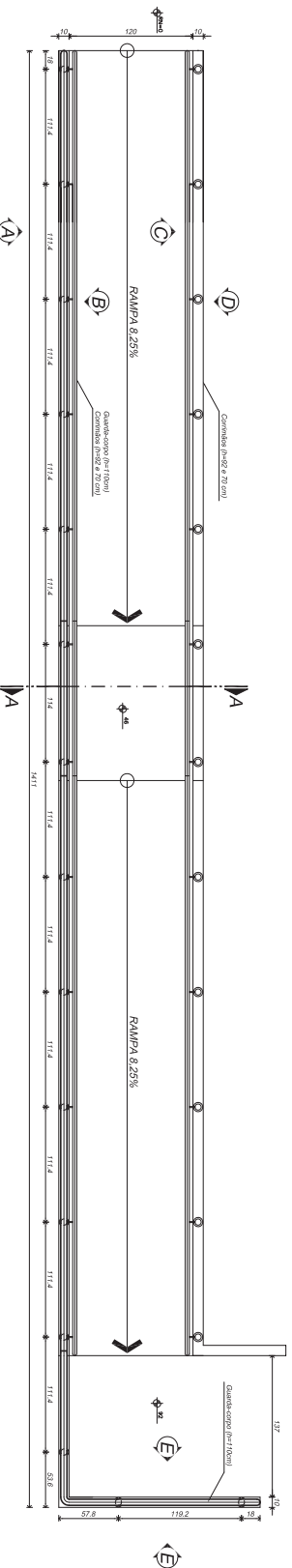

ATENÇÃO: AS ESPECIFICAÇÕES DOS MATERIAIS SERÃO ENCONTRADAS NO MANUAL DESCRITIVO DO CADERNO.	
Tribunal Regional Eleitoral de Santa Catarina	
PROJETO DE SERRALHERIA	
LOCAL: CARTÓRIO DA 3ª ZONA ELEITORAL - TIUBO TRAVESSA 1ª PARALELA EILBERTA 1772 ESCOLA COOP RUA DOULBE DE CAIXA - TIUBO/SC DELIMITAÇÃO MANUAIS DE ACESSO QUADRO-COMBO E CONTORNOS	ESCALA: S/ESCALA DATA: 06/08/2015
RESPONSÁVEL TÉCNICO: Kátia Lages Pereira Arquiteta Responsável pelo Projeto Rodrigo Polissart Arquiteto Responsável pelo Projeto	ESCALA: 1/50 DATA: 06/08/2015
RESPONSÁVEL EXECUTIVO: Filipe Schmidt Peronetto Técnico de Arquitetura	ESCALA: 1/50 DATA: 06/08/2015
RESPONSÁVEL FISCAL: Tribunal Regional Eleitoral de Santa Catarina Departamento de Engenharia	ESCALA: 1/50 DATA: 06/08/2015
ARQ 02/02	